

MOPA 532-700mW

Diode pumped passively Q-switched solid state laser

- 532 nm
- Single Pulse
- ≤ 1.3 ns
- 1 – 20 kHz
- > 700 mW
- External / Internal Trigger Mode

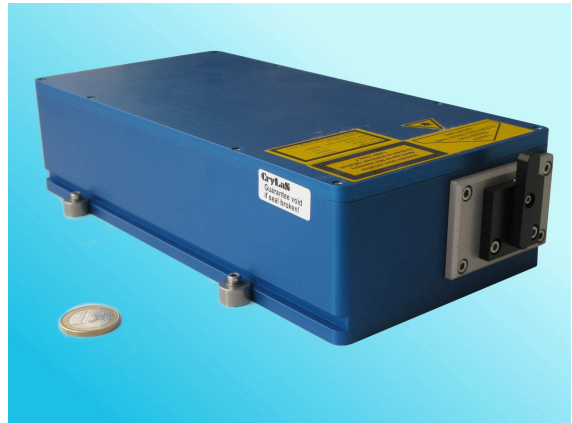

biology · biomedicine · chemistry · analytics

Optical Data	Wavelength	532 nm
	Average Power	> 700 mW @ 15 kHz
	Pulse Energy	> 48 μ J @ 15 kHz
	Beam Divergence (full angle)	< 3.0 mrad
	Beam Ellipticity	< 2:1
	Beam Diameter	0.7 \pm 0.3 mm (at laser exit)
	Spatial Mode	TEM ₀₀
	Pulse Repetition Rate (with external trigger)	1 Hz - 20 kHz
	Pulse Width (FWHM)	≤ 1.3 ns
	Polarization Ratio	> 100:1, vertical
	Pulse Energy Stability (averaged over 8 hrs)	< ± 3 % @ 15 kHz
	Pulse-to-Pulse Energy Stability (over 60 sec)	< ± 8 % (< 2.5 % rms)
	Laser Classification	4 / IV
Optical Output	Free Beam	
Electrical Data	Electrical Power Consumption	< 250 W
	Line Voltage	90 - 265 V AC (50-60 Hz)
Interface	USB	
	BNC connector for external triggering (TTL)	
	SMB connector for 24 V DC output	
Miscellaneous	Warm-up Time	< 10 min
	Operating Temperature	18 - 38 $^{\circ}$ C
	Laser Head Size	61 x 120 x 314 mm (H x W x L)
	Stand-Alone Unit Size	184 x 343 x 375 mm (H x W x L)
Options	Multimode fiber coupling	
	Synchronization signal output (rise time < 2 ns)	
	Electrical or manual wavelength switch (355nm – 532nm) or electrical beam blocker	
	External telescope (beam expander) / Electrical or manual attenuator	

Laser Head and Controller

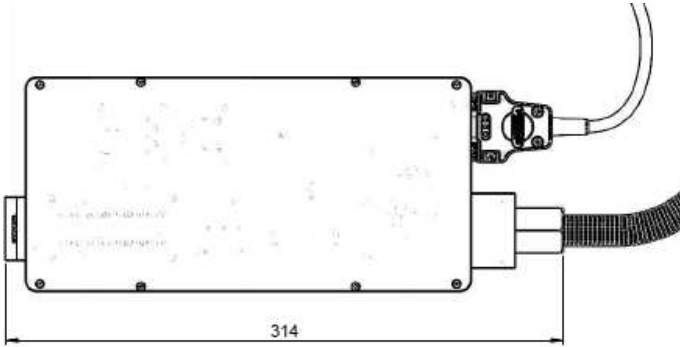
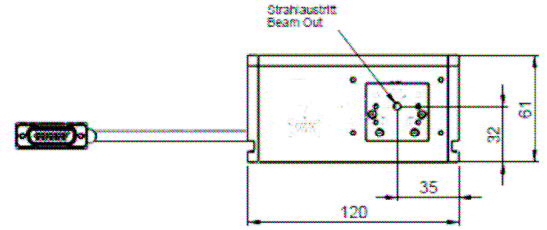
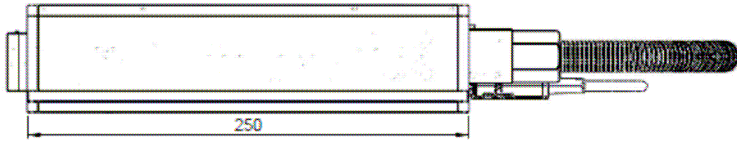

Laser Head
(height = 61; width = 120; length = 314
core dimensions in mm)

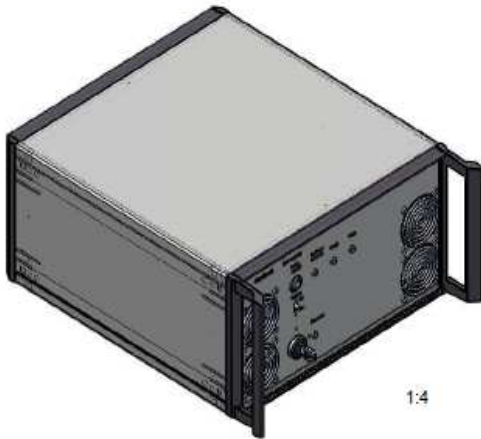

Controller
(height = 184, width = 343; length = 375
core dimensions in mm)

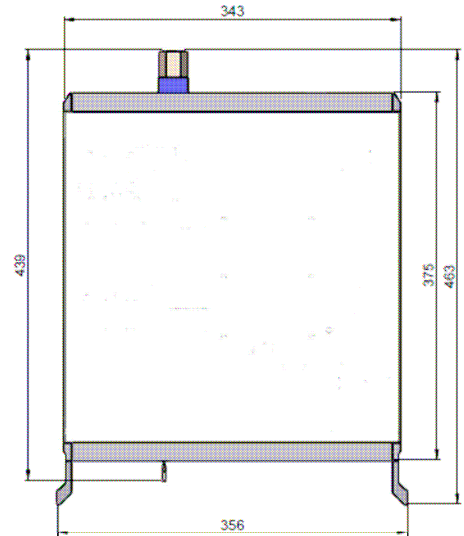

Laser Safety Labels

The MOPA 532-700mW lasers are class 4 / IV according to IEC 60825-1:2007

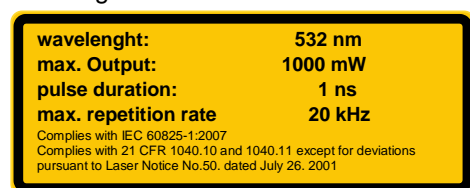
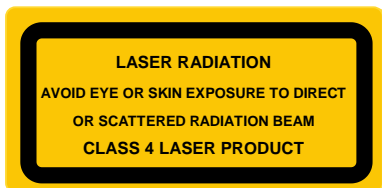

Mar, 2013